



2634

# AIRIDE

firestoneairide.com

## INSTALLATION INSTRUCTIONS

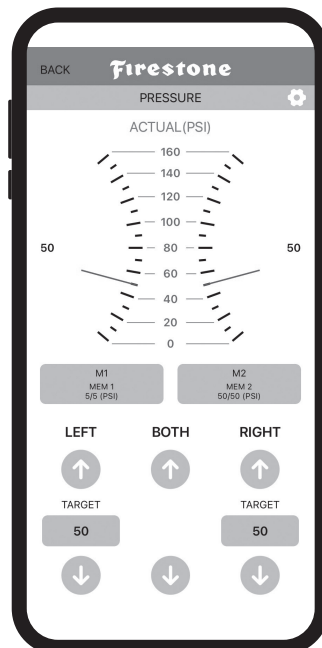
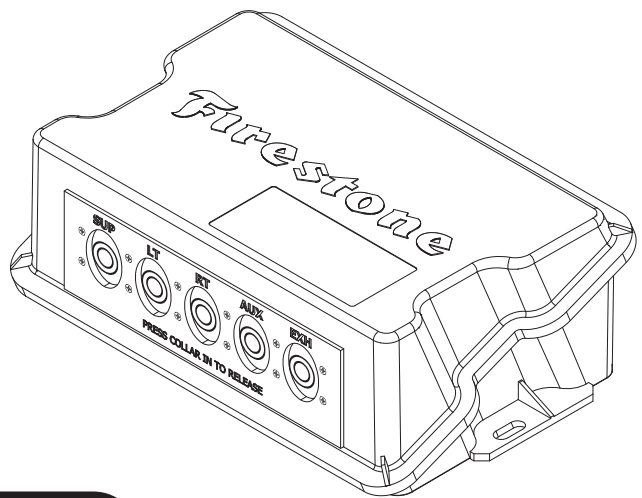
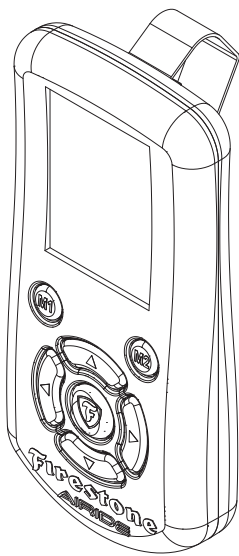

# **IMPORTANT**

*PLEASE DON'T HURT YOURSELF, THE KIT, OR YOUR VEHICLE. TAKE A MINUTE TO READ THIS IMPORTANT INFORMATION.*

## **SAFE INSTALLATION**

Please take all safety precautions during installation. A hydraulic jack can fail, and if that happens, you can be seriously hurt, or worse, if you are relying on it to hold up the vehicle. If you use a hydraulic jack, secure jack stands in the appropriate locations and chock any tires still touching the ground.

Wear safety glasses or goggles. Your eyes may be lower than some parts and pieces, and you don't want to lose an eye.

Remove the possibility of any electrical issues by disconnecting the negative battery cable.

## **VEHICLE GVWR**

NEVER exceed the maximum load recommended by the vehicle manufacturer (GVWR). The GVWR can be found in your vehicle's owner's manual or on the data plate on the driver's side door. Consult your local dealership for additional GVWR specifications.

## **PRESSURE TO LOAD**

Be sure to review the load limits noted in the Air Spring Kit Installation Instructions (sold separately).

## **APPROPRIATE AIR PRESSURE**

For best ride, use only enough air pressure in the Air Springs to level the vehicle when viewed from the side (front to rear). This will vary, depending on the load, location of the load, condition of the existing suspension, and personal preference.

**ONCE INSTALLED SUCCESSFULLY, FOLLOW THE PRESSURE REQUIREMENTS FOR THE AIR SPRINGS.  
FOR FIRESTONE, GENERALLY:**

### **COIL-RITE**

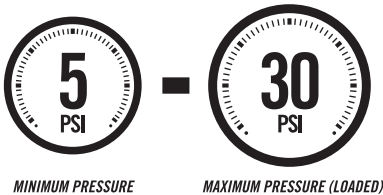

### **RIDE-RITE**

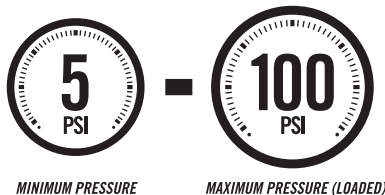



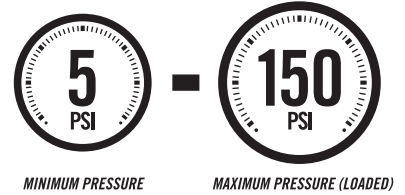



### **RED LABEL**



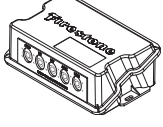
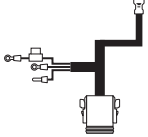
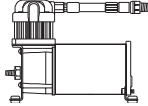
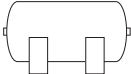













# PARTS

Compare the parts below to your kit. Ensure you have all pieces, and organize them for an easier installation.

## MAIN KIT CONTENTS

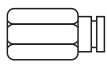
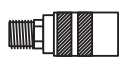
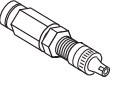
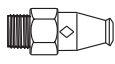
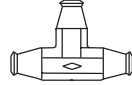
<b>PT # 9965</b> <i>The 9961 ECU and 9962 Wire Harness are packaged inside one box under the 9965 part number.</i>		<b>PT # 9961</b>  x1 ECU	<b>PT # 9962</b>  x1 WIRE HARNESS
<b>PT # 9287</b>  x1 AIR COMPRESSOR 450C	<b>PT # 9126</b>  x1 AIR TANK 2 GALLON	<b>PT # 9416</b>  x1 AIR TUBING (30 FEET)	
<b>PT # 9194</b>  x1 EXTERNAL HOSE	<b>PT # 9195</b>  x1 INFLATOR AND GAUGE KIT	<b>PT # 9301</b>  x1 STORAGE BAG HEAVY DUTY	
		<b>PT # 9964</b>  x1 AIR COMMAND DUAL REMOTE	

## A21-760-2634 HARDWARE PACK

<b>PT # 3087</b>  x4 10-32 x 1" MACHINE SCREW			
<b>PT # 3421</b>  x1 10-16 x 3/4" SELF-TAPPING SCREW	<b>PT # 3093</b>  x2 10-32 x 3/4" MACHINE SCREW	<b>PT # 0070</b>  x4 3/8-16 x 1.00 HEX HEAD CAP SCREW GR2	
<b>PT # 3086</b>  x12 #10 FLAT WASHER	<b>PT # 3088</b>  x6 10-32 NYLOCK NUT	<b>PT # 3067</b>  x4 3/8-16 HEX HEAD FLANGE CENTER LOCK NUT	
<b>PT # 3046</b>  x3 1/4 STRAIGHT FITTING PTC	<b>PT # 0071</b>  x8 3/8 FLAT WASHER	<b>PT # 9483</b>  x1 INFLATION VALVE MOUNTING BRACKET	
<b>PT # 3146</b>  x1 1/4 NPT ANCHOR COUPLING	<b>PT # 3083</b>  x1 1/4 NPT FEMALE 1/4 PTC	<b>PT # 9196</b>  x1 DRY COUPLER FITTING	
<b>PT # 3032</b>  x2 INFLATION VALVE AND VALVE CAP ASSEMBLY	<b>PT # 3055</b>  x1 1/8 NPT PUSH-TO-CONNECT STRAIGHT FITTING	<b>PT # 3025</b>  x2 1/4 PUSH-TO-CONNECT TEE	
<b>PT # 9036</b>  x20 RED NYLON TIE	<b>PT # 9488</b>  x4 LARGE NYLON TIE	<b>PT # 0899</b>  x4 THERMAL SLEEVE	

# CONTENTS AND OVERVIEW

PAGE 4	PLANNING THE INSTALL
PAGE 5	PREPARE THE AIR COMPRESSOR AND TANK
PAGE 6	DRILL HOLES FOR AIR COMPRESSOR AND ECU
PAGE 7	INSTALL MAIN COMPONENTS
PAGE 8	INSTALL THE AIR TUBING
PAGE 9	INSTALL THE WIRE HARNESS
PAGE 10	INSTALL BULKHEAD ASSEMBLY, USING INFLATOR, CLEAN UP INSTALLATION
PAGE 11	ECU POWER UP/ APP PERFORMANCE
PAGE 13	USING THE AIR COMMAND™ DUAL APP
PAGE 15	USING THE AUXILIARY PORT
PAGE 17	AIR COMMAND™ DUAL REMOTE QUICKSTART GUIDE
PAGE 21	TEST THE SYSTEM
PAGE 22	FIX AN AIR LEAK

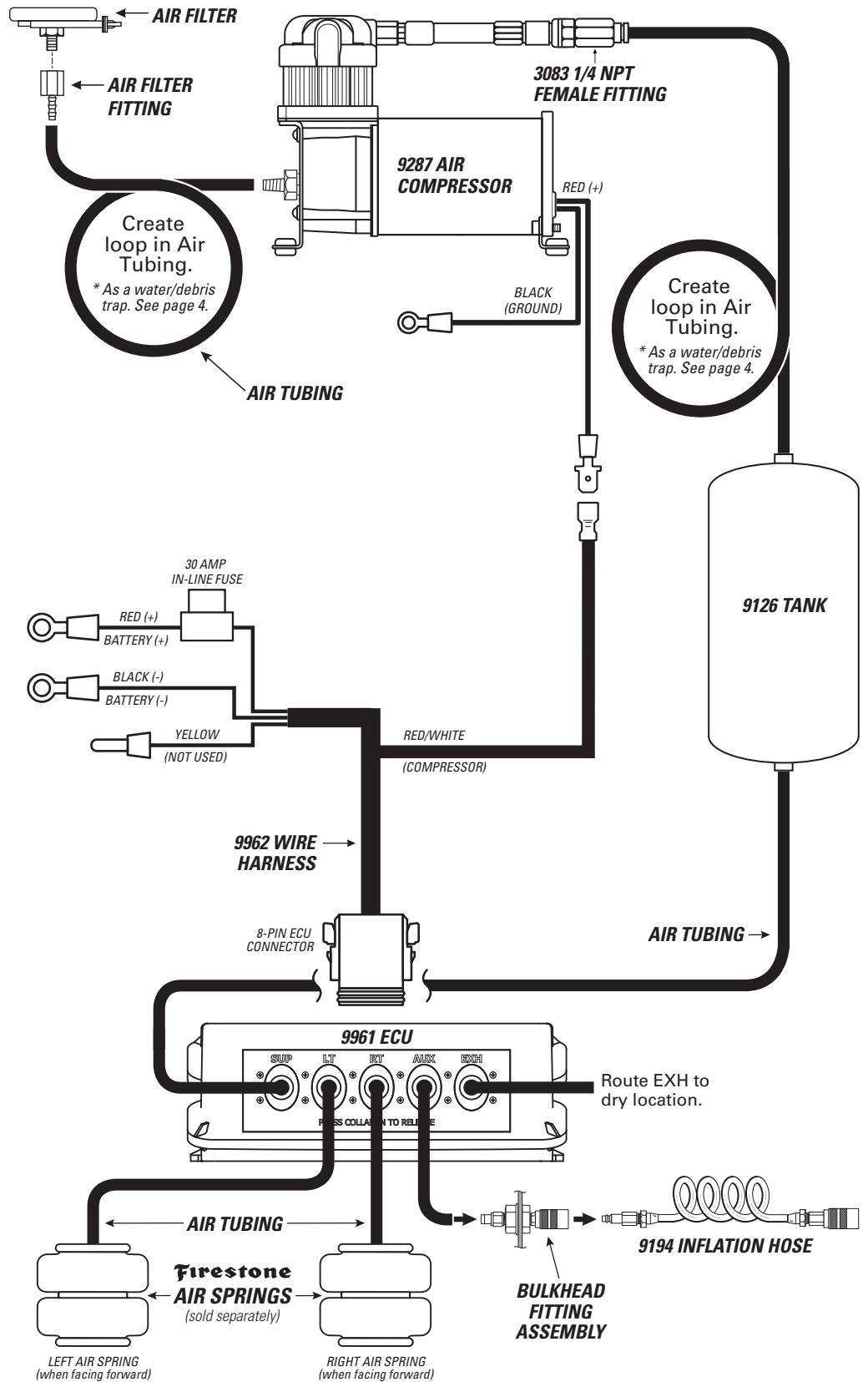

# PLANNING THE INSTALL

THESE PLANNING STEPS WILL HELP YOU SAVE TIME AND WILL MAKE THE INSTALLATION EASIER.

## **DETERMINE THE MOUNTING LOCATION FOR THE AIR COMPRESSOR**

- Provides ample air flow and is protected from airborne debris and moisture.
- Mount close enough to the ECU to allow Wire Harness connections to reach.
- If using the optional Firestone Air Accessory Mounting Kit, consider the guidelines above, and follow the kit's instructions.

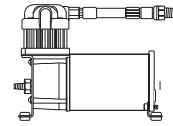

## **DETERMINE THE MOUNTING LOCATION FOR THE ECU**

- Mount close enough to the Air Compressor to allow Wire Harness connections to reach.
- Allow room for Air Tubing to connect to the Air Fittings on the ECU.
- Allow room for the 8-pin ECU connector to connect to the ECU.
- Allow room for the Air Tubing to run without sharp curves or bends.
- Using supplied fasteners shown in Step 3 is recommended. If no other mounting option is available, see the sidebar on Step 2 for using the Large Nylon Ties.
- Select a location that is solid and secure on the body or frame of the vehicle, away from any moving parts, electrical or any other lines.

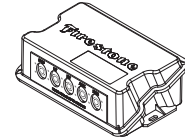

## **PLAN INSTALLATION ROUTES FOR WIRING AND AIR LINES**

- Make sure the Wire Harness and Air Tubing are not exposed to sharp metal edges that can damage them.
- Use supplied Thermal Sleeves on Air Tubing when routing near heat sources.
- Use supplied Nylon Ties to secure Air Tubing and Wire Harness to the vehicle.
- Make a loop in the Air Tubing where shown. This creates a water/debris trap that protects the Air Compressor.
- Measure twice, cut once!

## **TAPE ALL ELECTRICAL CONNECTIONS**

- Use electrical tape to appropriately secure and protect all electrical connections.

## **USING PUSH-TO-CONNECT FITTINGS FOR AIR LINES**

Your kit includes Push-to-Connect fittings to connect the Air Tubing to hardware. Use the instructions below when using the Air Tubing.

- 1** Insert end of Air Tubing into Air Fitting.

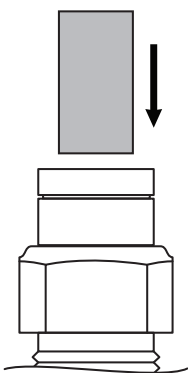

- 2** Push Air Tubing into Air Fitting as far as possible.

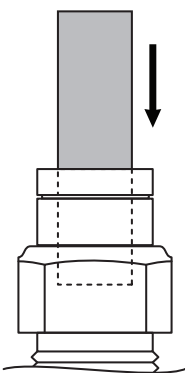

- 3** Gently pull on the Air Tubing to check for a secure fit.

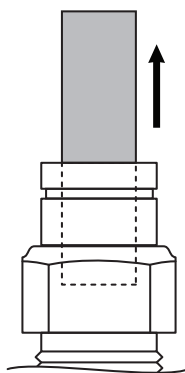

- 4** To remove, push down collar and gently pull Air Tubing away.

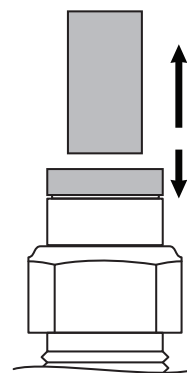

**Removal Tip:** Use a 1/4", 5/16", or 6mm open-ended wrench to push the collar down.

# 1

## PREPARE THE AIR COMPRESSOR AND TANK

*NOTE: Air Compressor can be mounted facing any direction.*

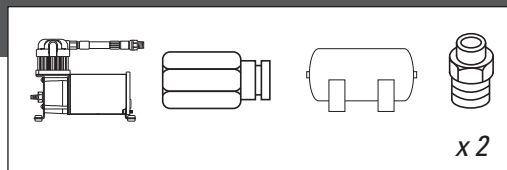

- 1 Install 1/4 Female NPT Push-to-Connect Straight Fitting on the Check Valve.

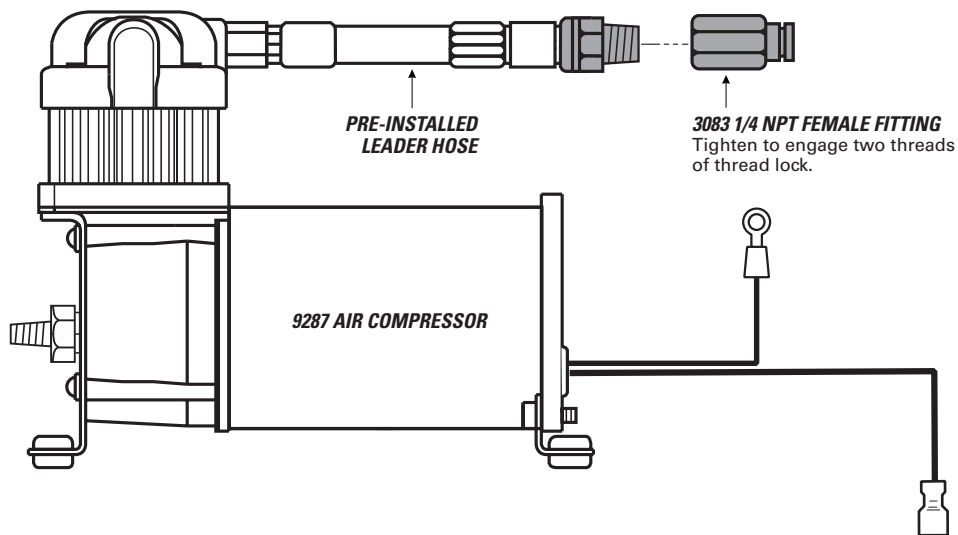

**AIR FITTING**  
Tighten to engage two threads of thread lock.

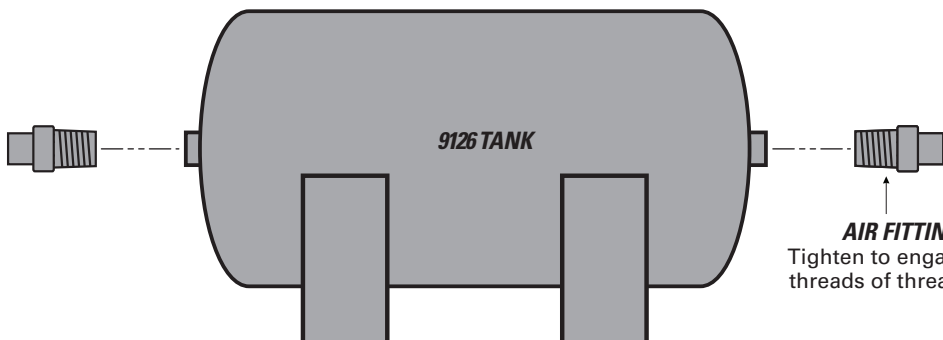

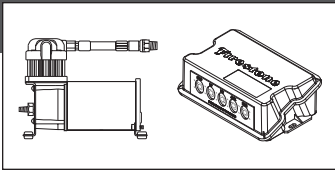

CHECK SURROUNDING AREA AND BACK SIDE OF MOUNTING LOCATION TO AVOID DRILLING INTO EXISTING LINES OR WIRING.



IF YOU ARE USING THE OPTIONAL FIRESTONE AIR ACCESSORY MOUNTING KIT, SKIP THIS STEP AND REFER TO THE MOUNTING KIT'S INSTRUCTIONS.

Drill within reach of the ground wire ring terminal on body or frame of vehicle or create a wire to link to the negative battery terminal. Minimum gauge of wire should be 12.

**AIR ACCESSORY MOUNTING KIT CANNOT BE USED AS A GROUNDING LOCATION FOR THE AIR COMPRESSOR.**

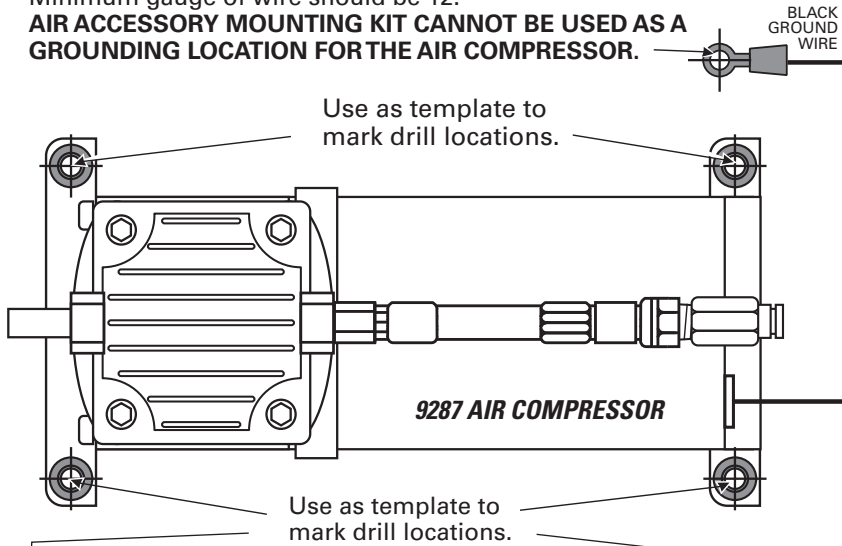

**1** Using the Air Compressor and ECU as templates, mark drill locations as shown with a punch or marking tool.

**2** Mark Air Compressor ground wire fastening location within reach of the ground wire ring terminal.

**3** Drill 7/32" diameter holes. Remove any burrs and debris from drill holes.



ASSURE THAT YOU INSTALL THE AIR COMPRESSOR AND ECU CLOSE ENOUGH SO THE CONNECTORS ON THE WIRE HARNESS WILL REACH THEM BOTH.

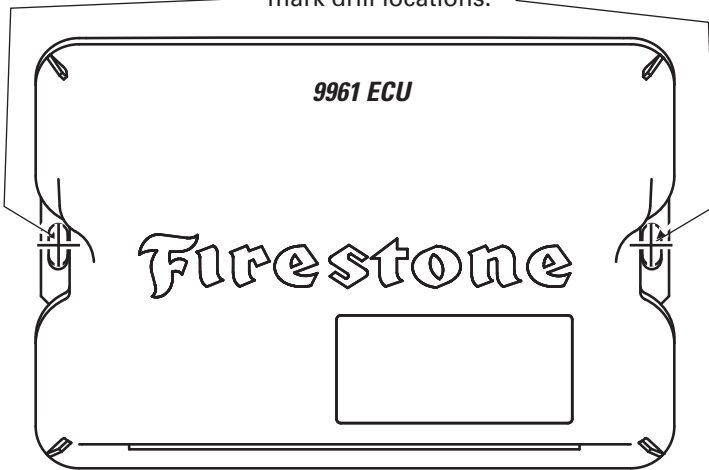

**OPTIONAL ECU MOUNTING**

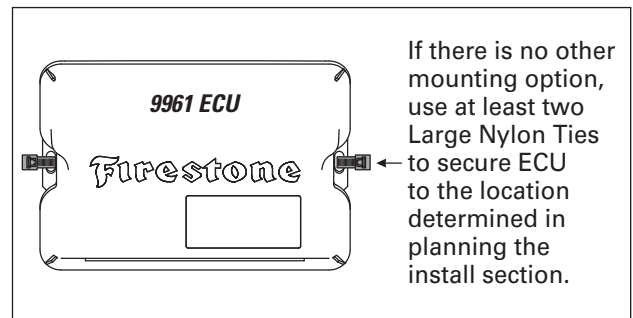

For tank mounts, make marks as shown below. The tank feet will mount at these locations.

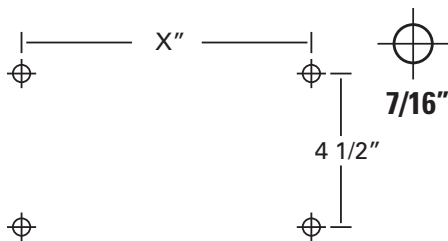

# 3

## INSTALL MAIN COMPONENTS

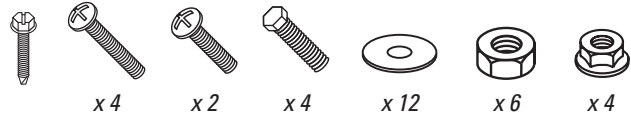

DO NOT OVER TIGHTEN MOUNTING BOLTS AND NUTS ON THE AIR COMPRESSOR. TOO MUCH TORQUE CAN CRUSH THE BRASS INSERTS AND RUBBER ISOLATORS.

**1** Mount the Air Compressor to the drill hole location using the supplied fasteners. DO NOT OVERTIGHTEN.

**2** Mount the ECU to the drill hole location using the supplied fasteners.

**3** Mount the black ground wire ring terminal using the supplied fasteners. Assure that the ring terminal makes a solid contact with bare metal for a proper ground.

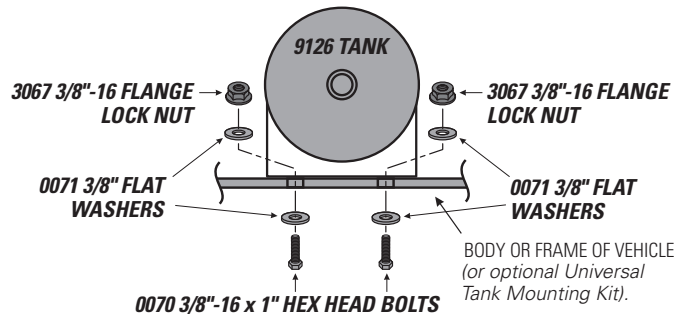
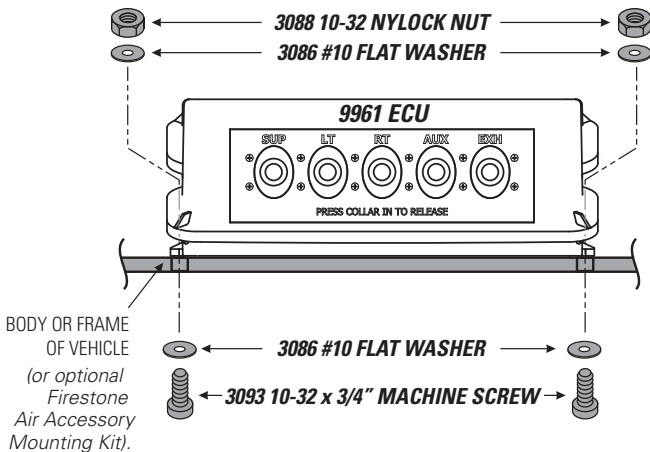
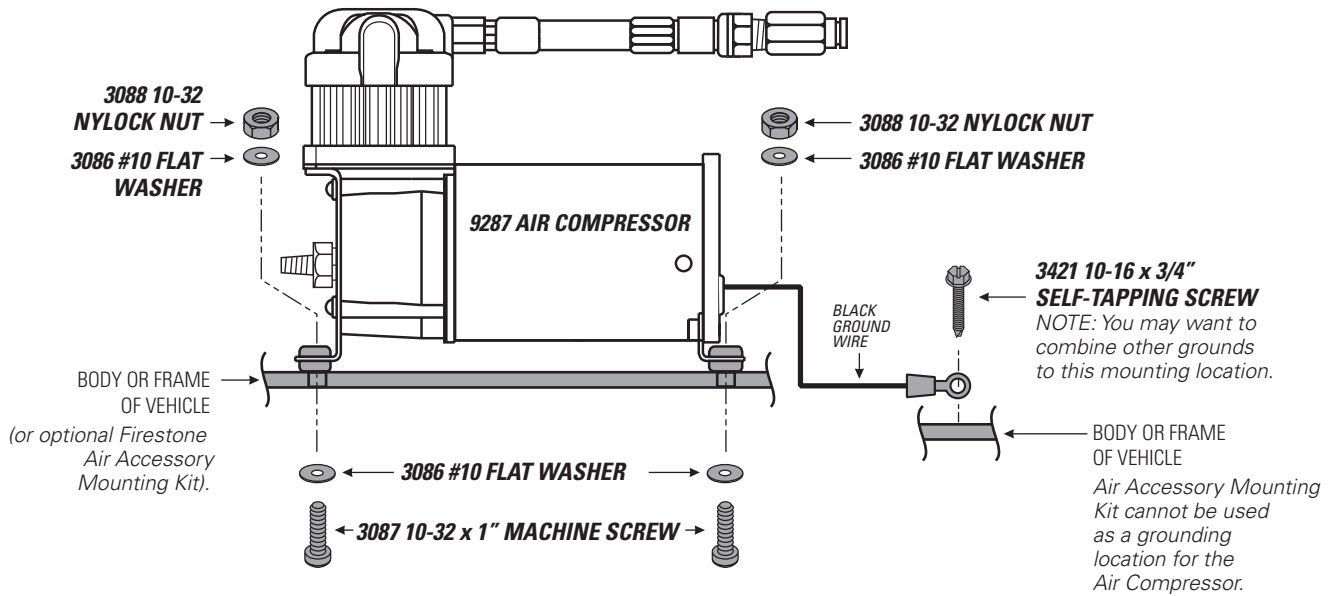





EXHAUST ALL AIR FROM THE SYSTEM PRIOR TO RELEASING AIR TUBING FROM AIR FITTINGS.



**1** Route the Air Tubing from the 1/4" NPT Female Fitting to the Tank and from the Tank to the Supply (SUP) Air Fitting on the ECU, leaving room to secure it safely. Use the guidelines on page 4 for proper Push-to-Connect Fitting install.

**2** Repeat Step 1 to route Air Tubing from the ECU to the Air Springs. Use the RT and LT Air Fittings on the ECU.

**3** Install Air Tubing to the Exhaust (EXH) Air Fitting to reduce exhaust noise and prevent dirt from clogging the port (recommended for off-road or dirty environments). Do not exceed 16" of Air Tubing, and secure it so the end turns to the ground.

**4** Use supplied Nylon Ties to install the Air Filter in a dry, secure place, away from dirt and debris. Periodically check the Air Filter during operation, and replace it when it becomes dirty.

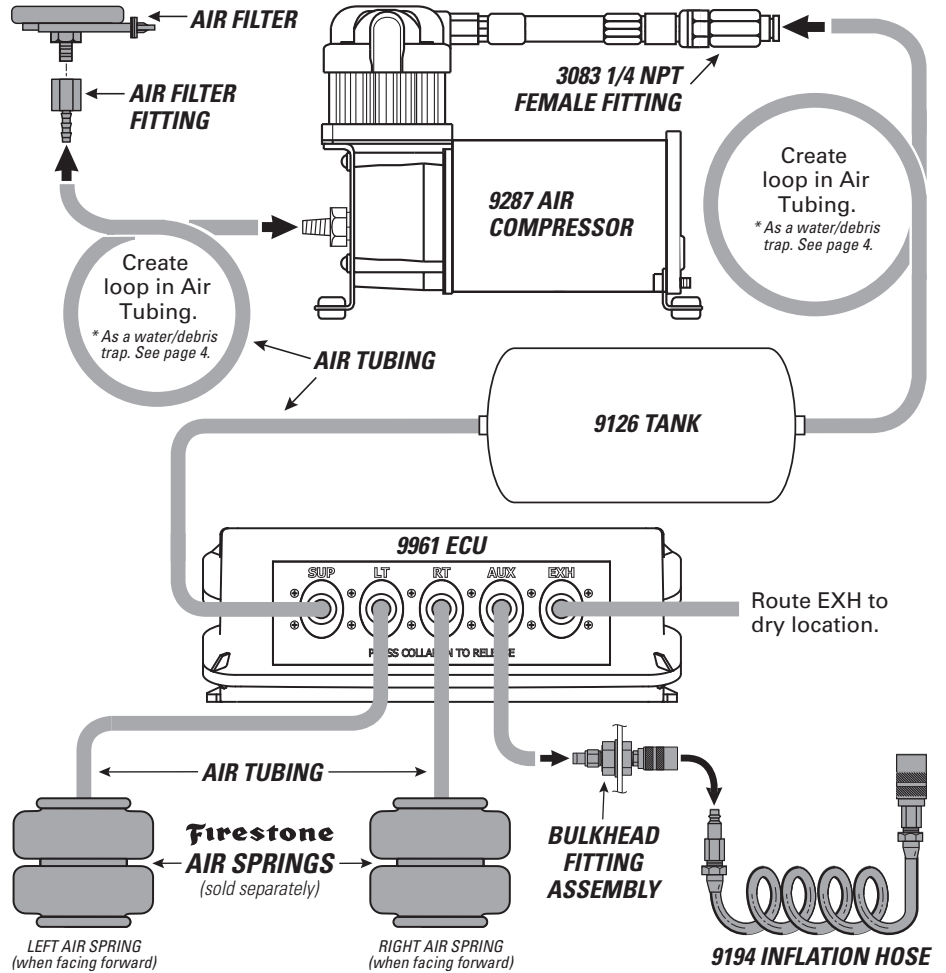

**DO**

Make sure the cut is as square as possible. Use a tube cutter or very sharp utility knife.

**DON'T**

Fold or kink the Air Tubing. Cut the Air Tubing at an angle. Use pliers, scissors, snips, saws, or side cutters.

**PROPER AND IMPROPER CUTS IN THE AIR TUBING**

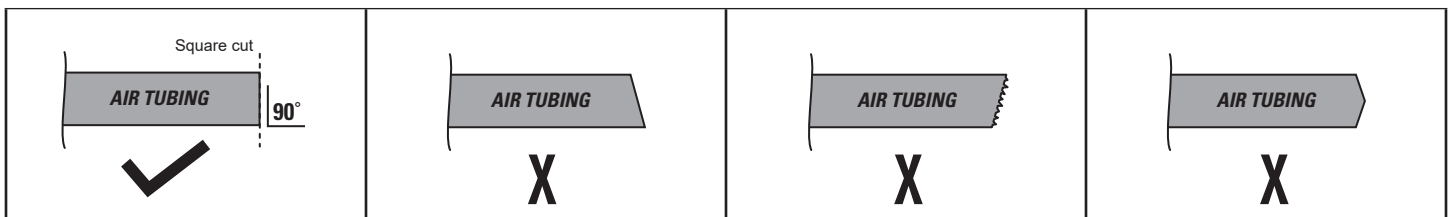

# 5

## INSTALL THE WIRE HARNESS

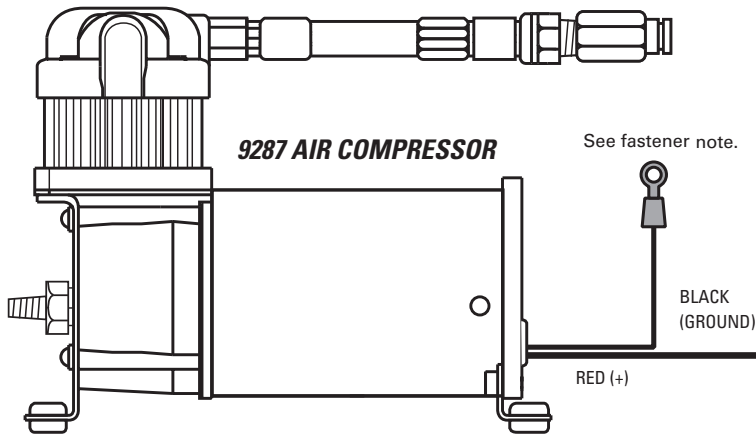
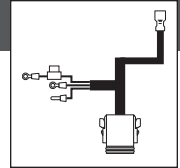

**1** Route the Wire Harness in the most protected manner possible, and securely make all connections as shown.



Why ground the Wire Harness to the battery? The ECU needs a good, clean ground for optimal accuracy. The Air Compressor can ground to the frame, but the ECU cannot.

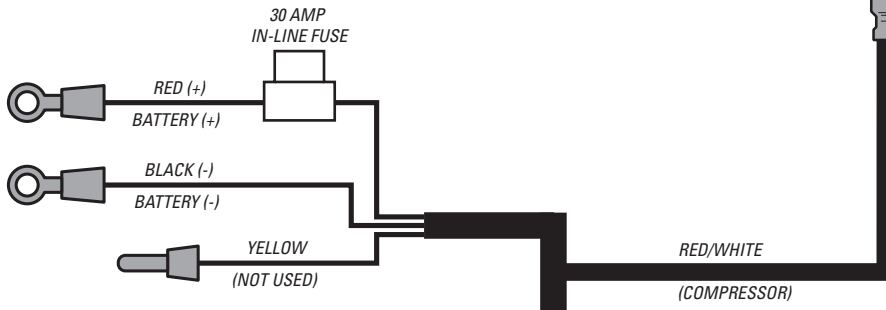

**9962 WIRE HARNESS**

8-PIN ECU CONNECTOR

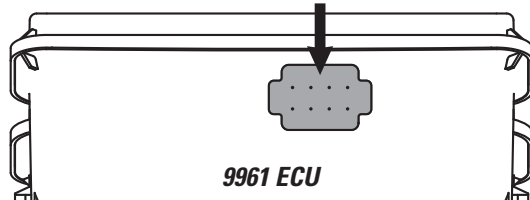

### ECU INDICATOR LIGHTS (Inside Case)

RED LED                      GREEN LED

**9961 ECU**

**Firestone**

**LEDs off** – ECU off

**Red LED flashing** – Errors are present

**Green LED flashing** – Bluetooth not connected, normal operation

**Green LED solid** – Bluetooth connected, Normal operation

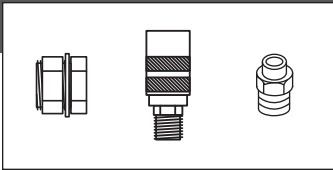

**1** Determine a suitable location to mount the Bulkhead Assembly and Fittings. This area should be convenient to access and safe from debris. Make sure you have room to attach the Inflation Hose.

**2** Drill a 3/4" hole in the selected mounting location and install the Bulkhead Assembly Components, Air Fitting and Dry Coupler Fitting, as shown.

**3** Install Air Tubing from the Push-to-Connect T-fitting between the Air Tank and the ECU to the Air Fitting installed into the Bulkhead Assembly.

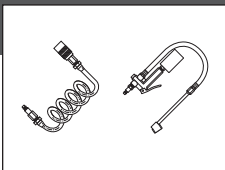
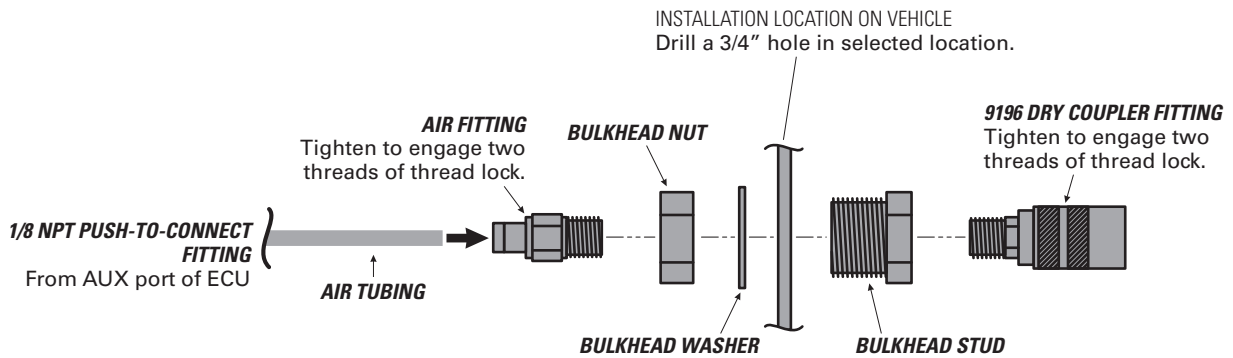

Connect the male Air Fittings to the Dry Couplers to use the Inflation Hose and Inflator. When finished, simply disconnect and store in the supplied Firestone Storage Bag.

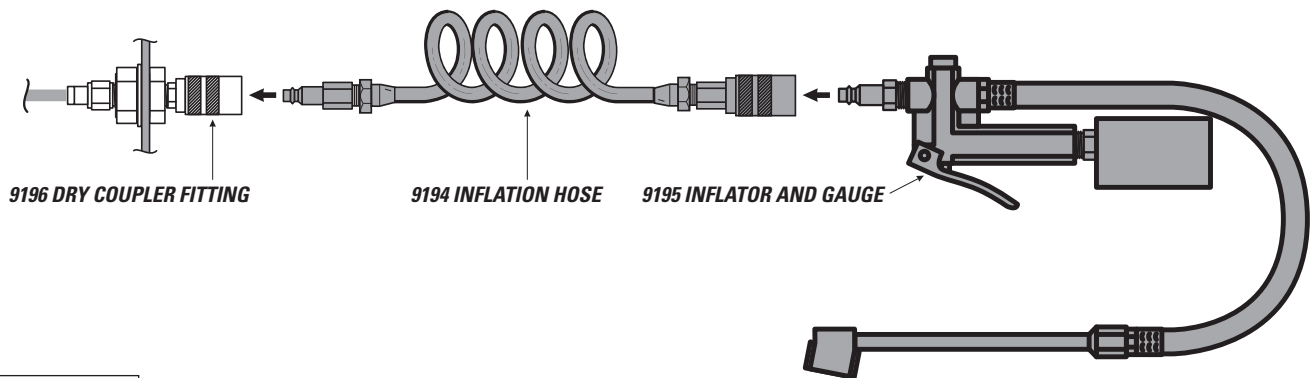

**1** Clean up the installation using supplied Nylon Ties, and return all factory parts and materials to operative state.

USING SUPPLIED NYLON TIES, SECURE ALL WIRING AND AIR TUBING IN A MANNER THAT DOES NOT OBSTRUCT MOVING PARTS OR IN ANY WAY THAT AFFECTS YOUR ABILITY TO SAFELY OPERATE THE VEHICLE.



**1** Download app from Google Play or Apple Store. Search for 'Air Command Dual'.

**2** Start the vehicle and open app.

**3** Select **SCAN** and click on the ECU from the screen.

**4** Follow onscreen prompts to link to the ECU and press **NEXT**.

**5** Default passkey is **123456**.

**6** Select 'Settings' icon and turn on **TANK MODE**. This will maintain the tank pressure at the desired settings (On 90 psi - Off 120, for example).

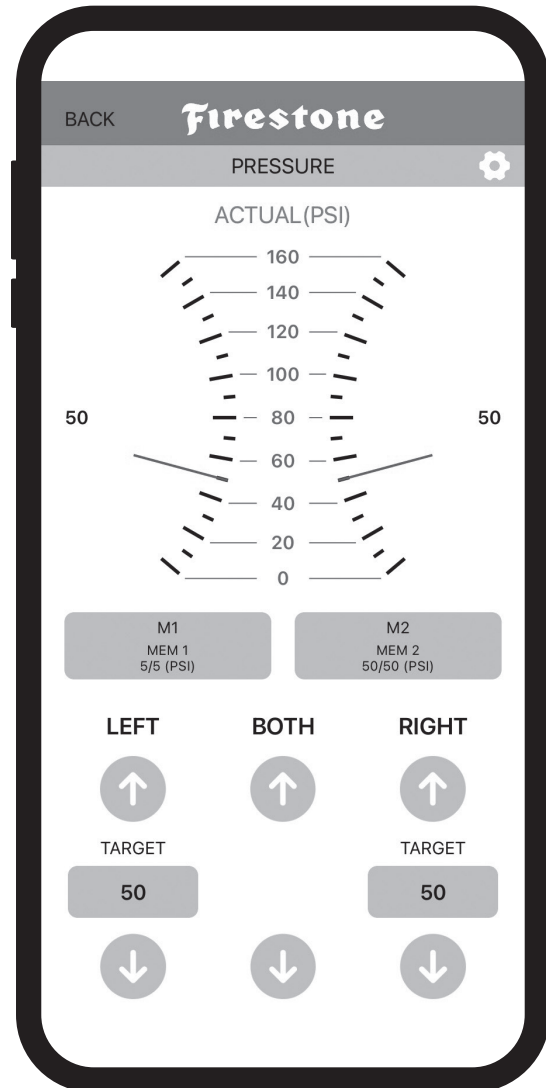

## 6 FACTORY RESET (TROUBLESHOOTING ONLY)

- Remove fuse from red wire by battery or remove wire harness connector from ECU
- Remove app from phone
- Reinstall fuse or plug wire harness connector back into the ECU
- Download the app

The ECU will remain active for two hours after initial installation or factory reset.

After voltage drop due to engine stop, the ECU will remain active for up to thirty minutes.

A SOLID GREEN LED  
ON THE ECU INDICATES  
BLUETOOTH IS CONNECTED

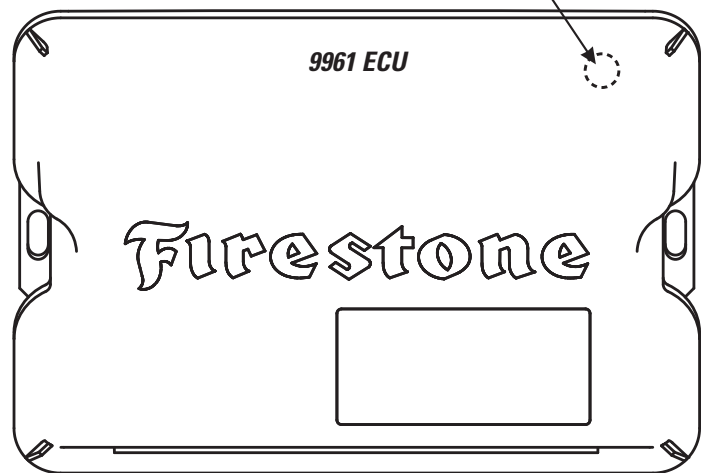

### ***OVER THE AIR FIRMWARE UPDATE***

**If an OTA update is available, a popup will appear on the app to activate.**

After voltage drop due to engine stop, the ECU will remain active for five minutes.

- If you select **SKIP**, the firmware can be updated once connected to the app
- If you select **INSTALL**, the firmware will begin to update. This will take approximately 3-4 minutes
- Keep the app open during the update and stay within range of the ECU until complete
- Once OTA is complete, restart the app, use the default passkey, and use as normal

### MAIN SCREEN

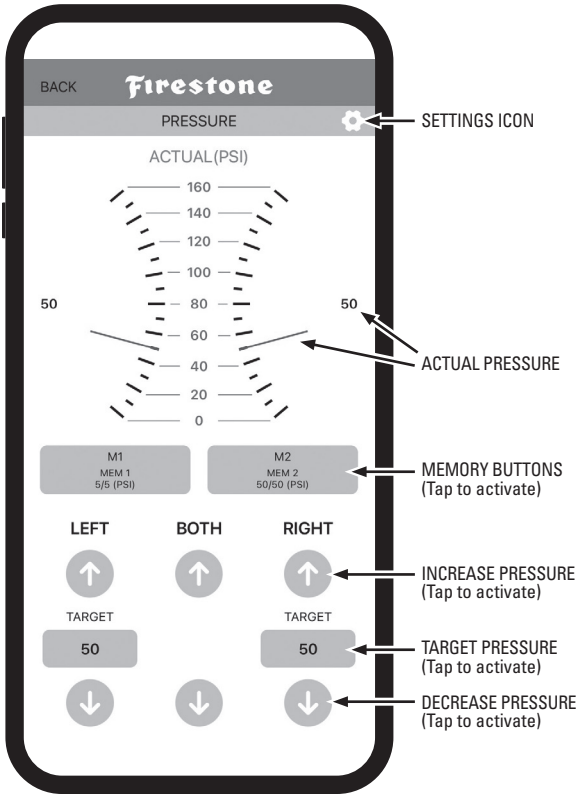

### SETTINGS

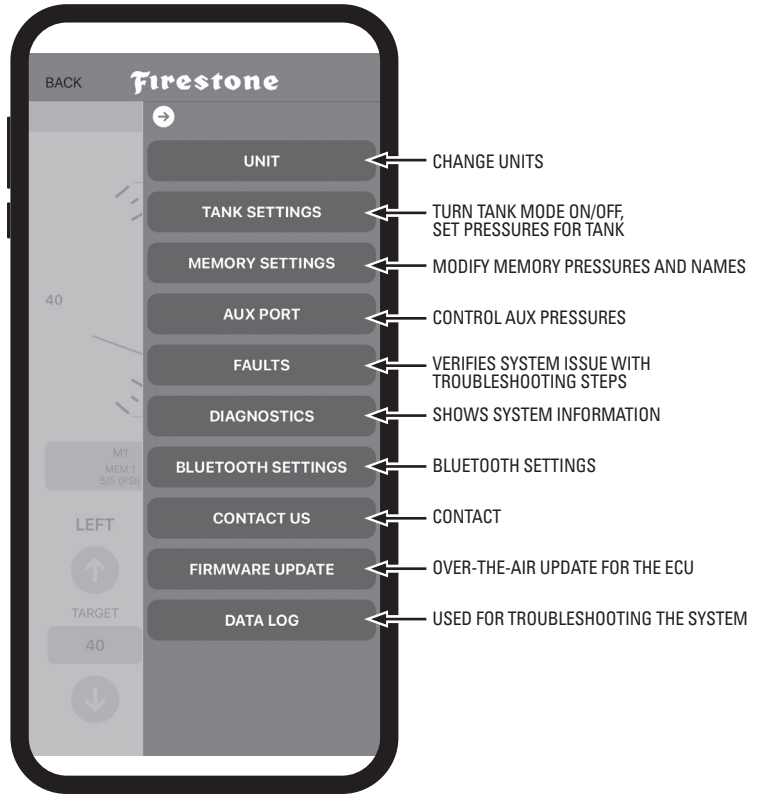

### TANK SETTINGS

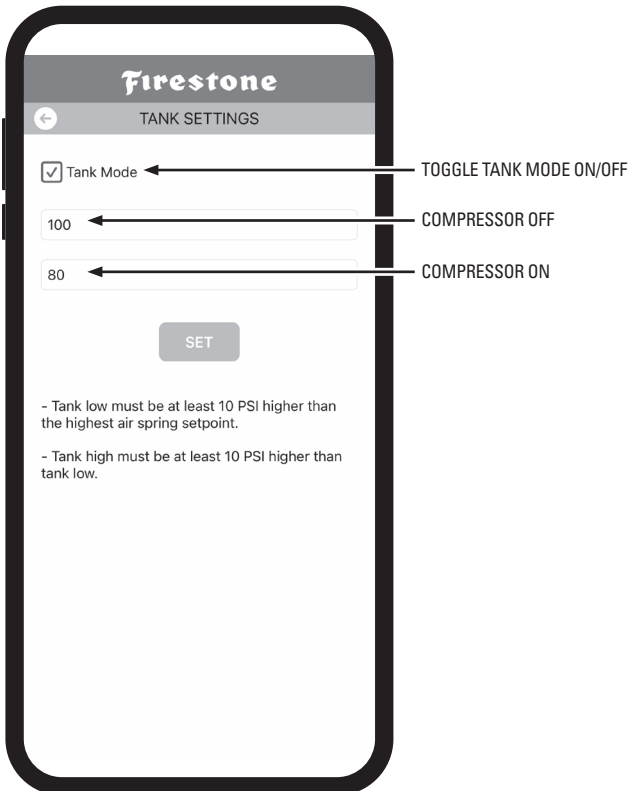

### MEMORY SETTINGS

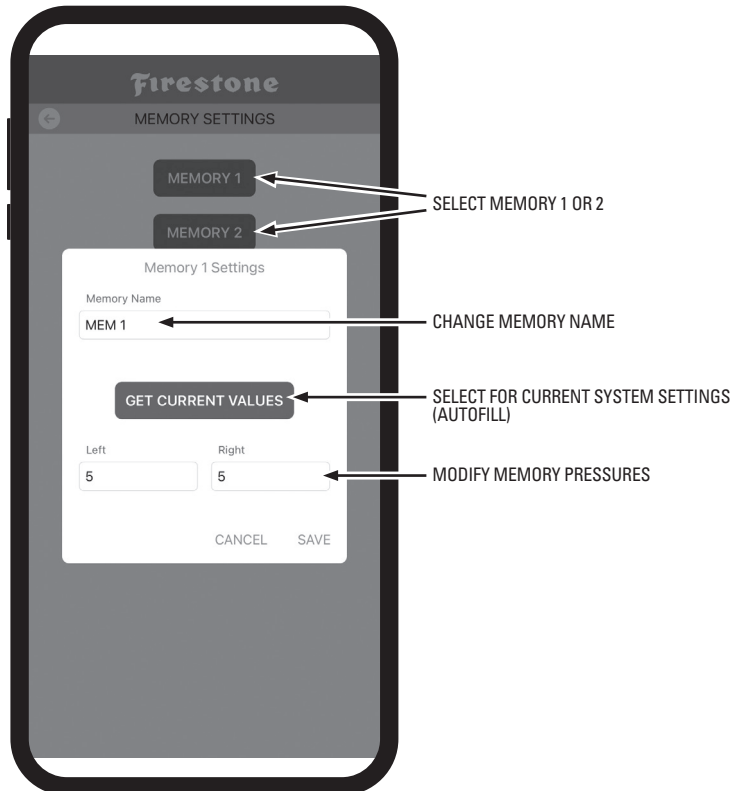

**AUXILIARY**

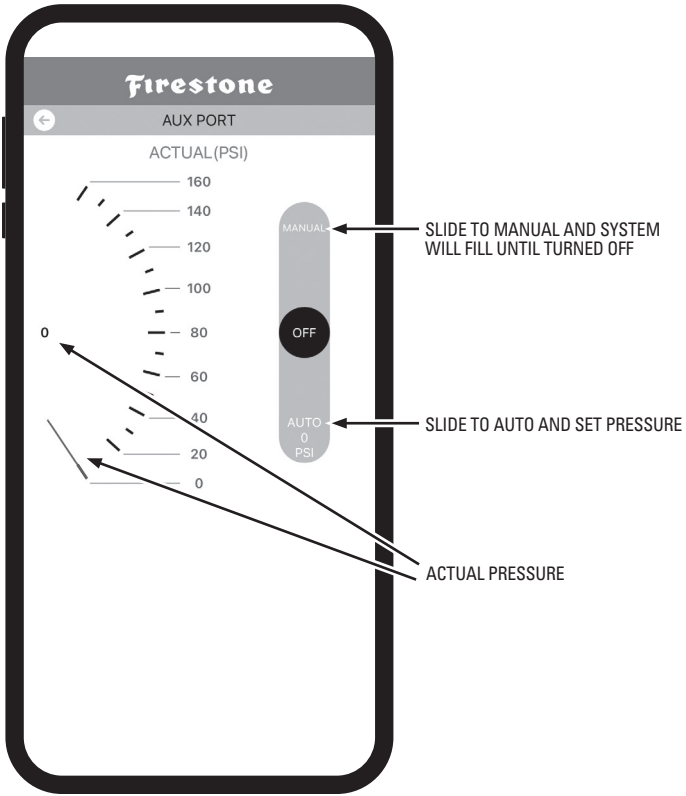

**SYSTEM FAULT**

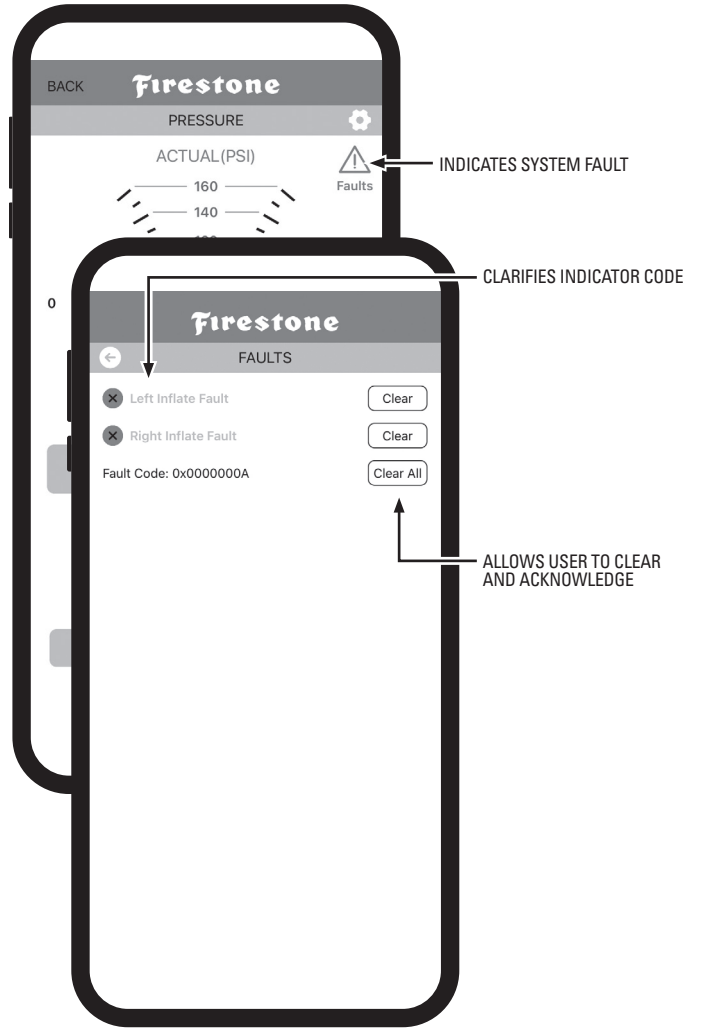

**DIAGNOSTICS**

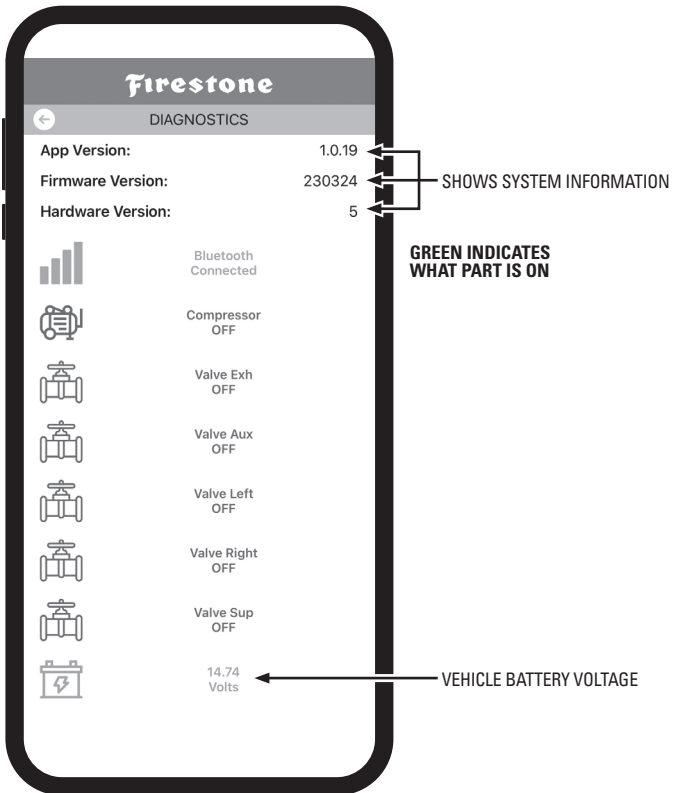

1 Select **AUX PORT** in the app settings menu

2 **MANUAL MODE**  
(slide from OFF to MANUAL)

- This will start the compressor and allow the user to monitor the air pressure that the auxiliary tubing is being used to fill.
- There is no timer using this setting

#### **AUTO MODE**

- Click **AUTO** and input a pressure
- Slide down to the AUTO setting to activate the system
- A timer will start to countdown and the system may cycle on/off as the external component is being filled

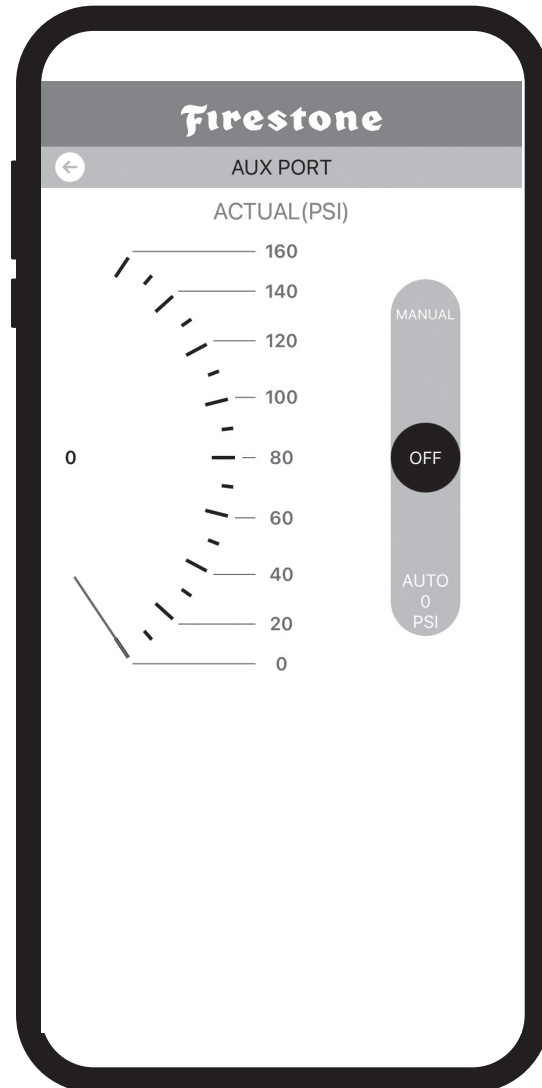





THE SYSTEM IS CONTROLLED BY THE USER TO FILL EXTERNAL ITEMS. IT IS THE RESPONSIBILITY OF THE USER TO INFLATE TO THE APPROPRIATE PRESSURE DETERMINED BY THE MANUFACTURER OF THE ITEM.

**DO NOT EXCEED THE CAPACITY OF THE FIRESTONE COMPRESSOR FOR RUNTIME (DUTY CYCLE) OR PRESSURE**

### 1 FUNCTIONS OF REMOTE BUTTONS

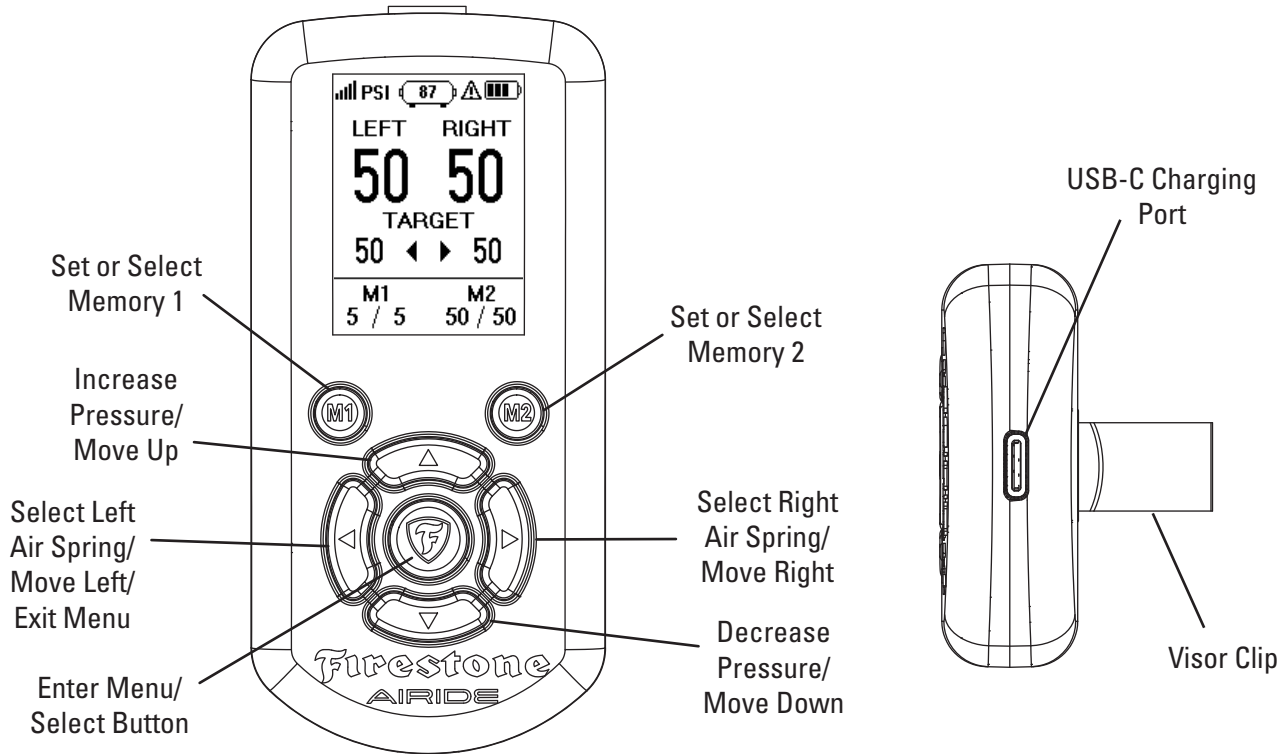

### 2 HOME SCREEN LAYOUT

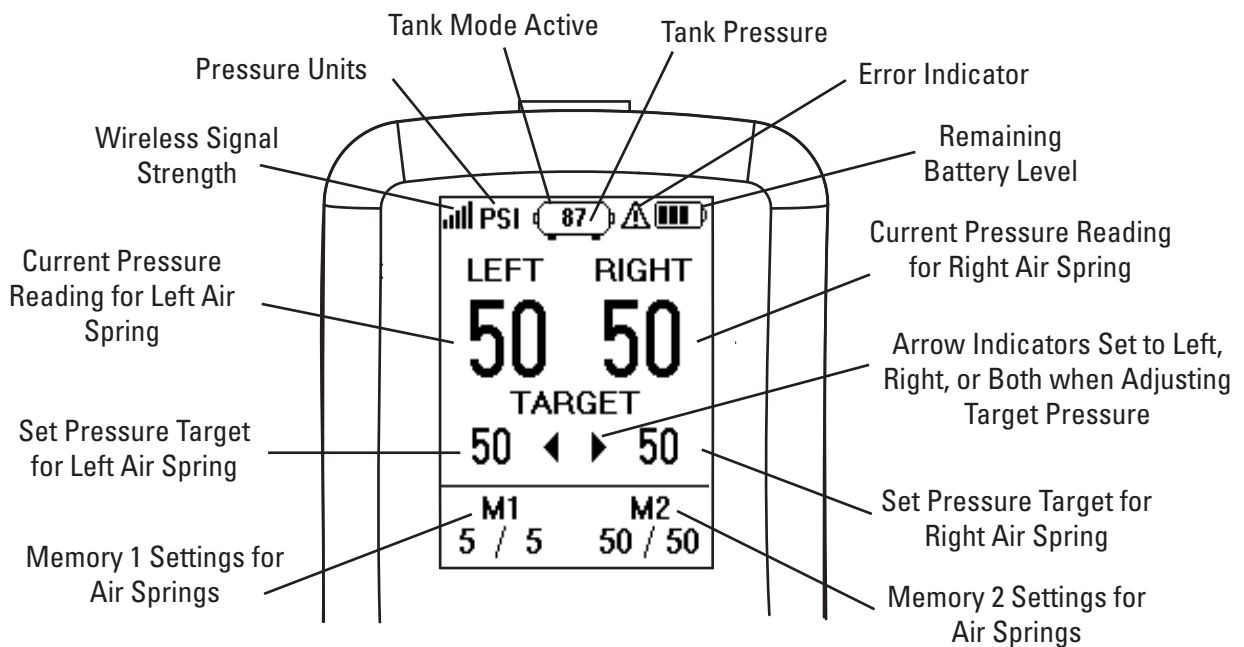

### 3 CONNECTING TO AN ECU

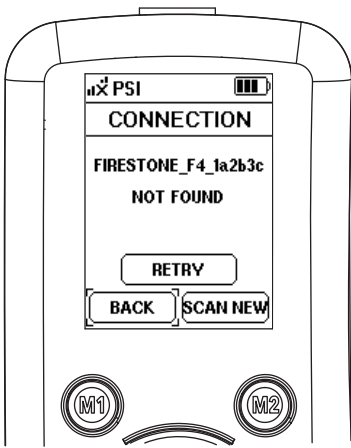

#### 1 Initial Connection

Each remote is tested and paired with an ECU prior to shipping to make sure it functions correctly. Expect to see that an ECU is not found when first turning on the remote.

Move to and enter the 'Scan New' function to find your ECU.

#### 2 Device Scan

This page shows all ECUs found when a new scan is complete. To make initial startup easier, only have one ECU powered on at a time. The first ECU found will automatically be selected and highlighted at the top of the screen. Press the F-shield Button to connect to that ECU.

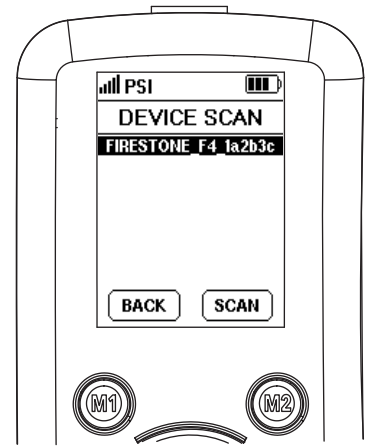

#### 3 Device Scan Continued

If no ECU is found, none will be selectable to connect to. If that is the case, please make sure power is getting to the ECU.

If the ECU has a green LED flashing the power is on, but no connection has been made. Once connected the LED should be stop flashing but stay green.

#### 4 Enter Passkey

The connection process requires a Passkey to pair with the ECU. The default Passkey is 123456.

If the ECU has been connected to a phone app double check that the Passkey is the same as on the app. The remote will ask for a different Passkey if incorrect. Once successful, the remote will return to the home screen.

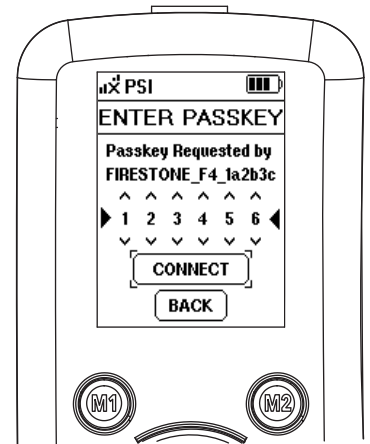
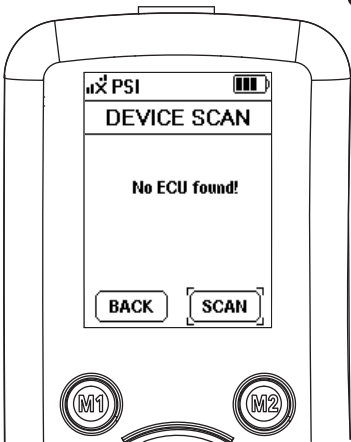

#### 5 Connection

Shows if the remote is connected to the system.

\**Not Found* is usually caused by the system not having power.

\**Not Connected* is usually caused by an incorrect Passkey. It has found the unit, but cannot connect.

#### 6 Change Passkey

It is possible to change the remote passkey in the menu settings shown on the next page.

\*Remember, the default passkey is 123456.

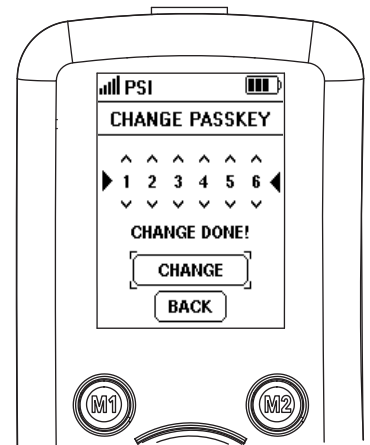
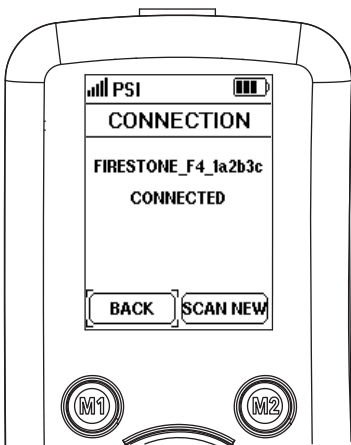

## 4 MENU SCREEN

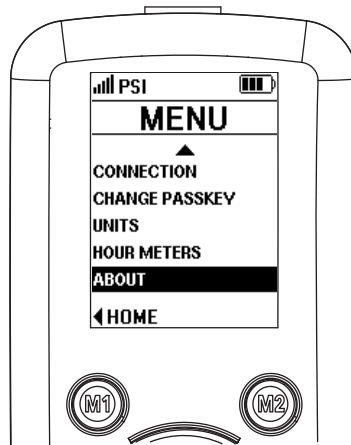
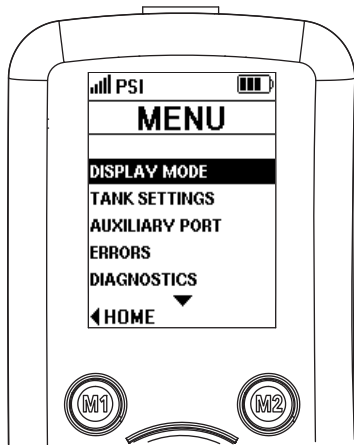

### Menu

Pressing the center F-Shield Button provides access to the remote menu. All additional settings are available here.

Use the Up ▲ and Down ▼ Arrow Buttons to navigate the menu. Press the Left ◀ Arrow to exit to the Home Screen.

## 5 ADDITIONAL FEATURES

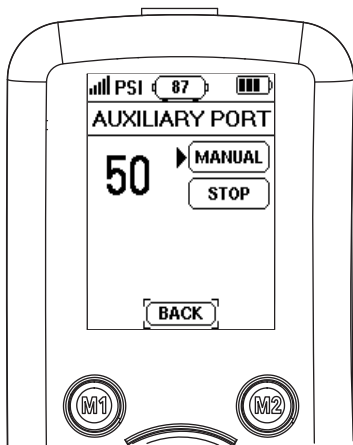

Manual Mode, when selected, will run the compressor until the user presses the stop button. Measured pressure is shown on the left.

### Auxiliary Port

Automatic Mode is only available when Tank Mode is not active. Set desired target pressure and compressor will run until pressure is met or it has ran for 60 seconds. It can be ran multiple times if needed.

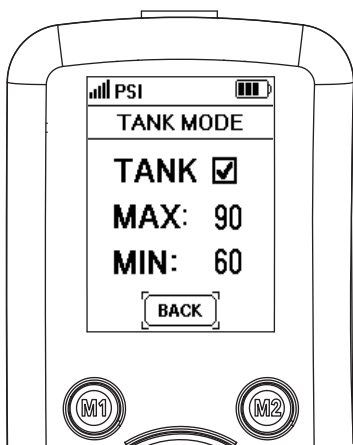
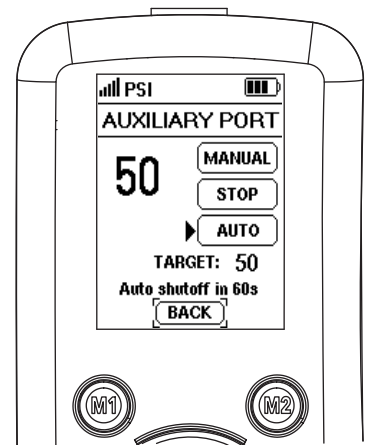

Check when a tank is connected to the air spring system.

Minimum pressure must be greater than pressure in the air springs.

Maximum pressure can be set at most 40 PSI greater than minimum pressure.

### Tank Mode

### Units

Select pressure unit of measure.

PSI - Imperial  
KPA - Metric (SI)  
BAR - Metric

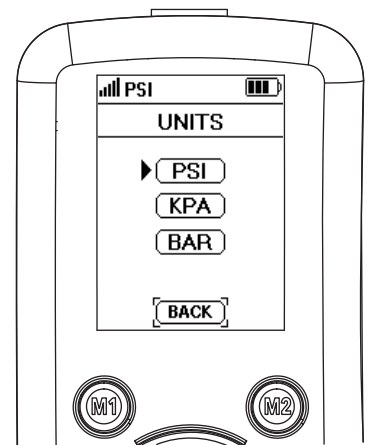

# 6 DATA ANALYTICS

## Errors

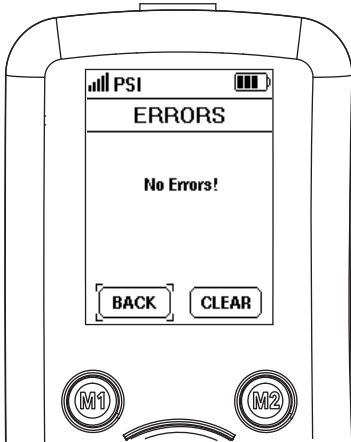

Error codes help diagnose issues with the physical system. These codes identify pressure leaks, inflation issues, wiring problems, etc. Refer to the troubleshooting guide in the manual provided in the Air Command Kit for working through initial common issues.

Once the issue is resolved make sure to clear the errors. This will also reset (remove) the error indicator from the top right of the screen and allow the system to operate normally.

If these codes or system issues persist, please reach out to [rrtech@fsip.com](mailto:rrtech@fsip.com).

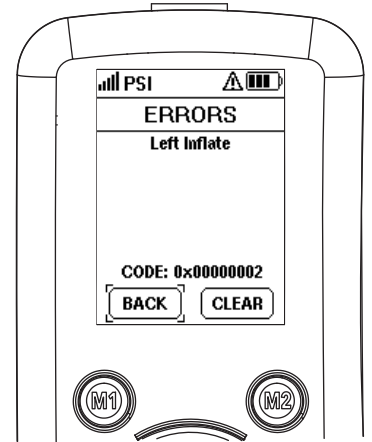

## Diagnostics

This page shows current operation of all air valves and compressor states (on or off) and the battery voltage coming into the ECU.

## Hour Meters

This page shows how long the ECU, compressor, and air valves have operated since the system was installed.

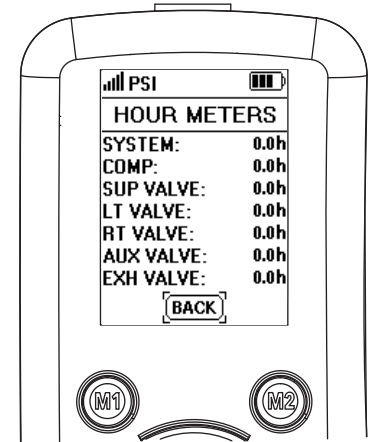
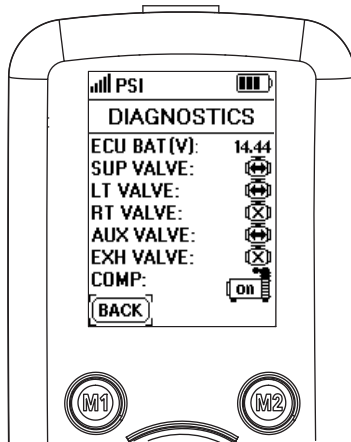

## About

This page provides the current Firmware and Hardware information for both the Remote and ECU.

## Display Mode

The Air Command Dual Remote comes standard with Dark Mode activated. The user has the ability to change between more or less LEDs lit depending on preference and ambient conditions.

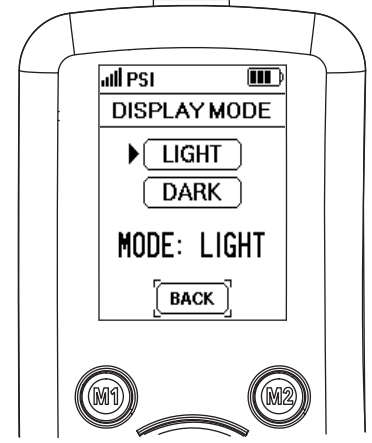
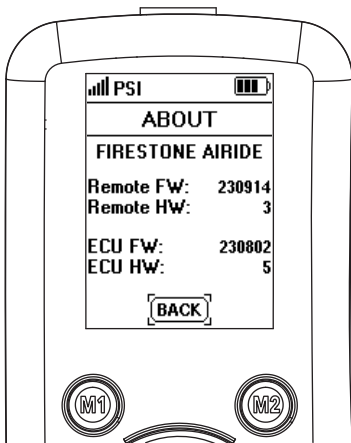

# 13

## TEST THE SYSTEM

With the Air Command™ Dual App and your Air Springs installed, you are ready to test the system.

- 1 Reattach the negative battery cable.

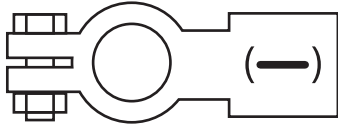

- 2 Turn on your vehicle's ignition.

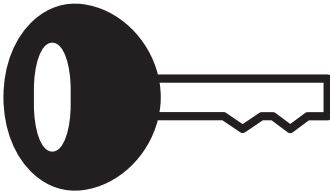

- 3 Use the Air Command™ Dual App or Dual Remote to inflate the Air Springs to 70 PSI. See Step 10 or 12 for details.

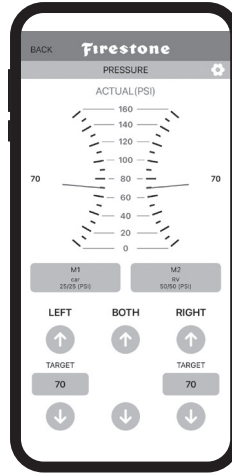

- 4 Spray fittings with soap and water mixture or glass cleaner.



- 5 Observe bubbles.

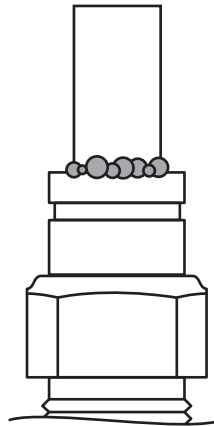

**SMALL SOAP BUBBLES THAT DO NOT EXPAND**

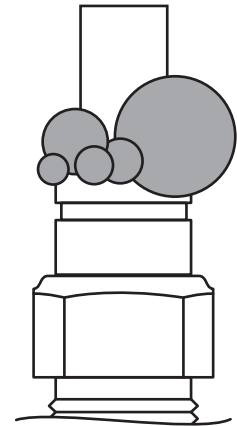

**SOAP BUBBLES THAT EXPAND**



# NO LEAKS?

Congratulations! You're riding right with the push of a button! Remember to review the Operating Instructions.

# LEAK?

Bummer. Continue to Step 14 to fix the leak.



**EXHAUST ALL AIR FROM THE SYSTEM PRIOR TO RELEASING AIR TUBING FROM AIR FITTINGS.**



- 1 Use the Air Command™ Dual App or Dual Remote to deflate the Air Springs to 5 PSI. See Step 10 or 12 for details.

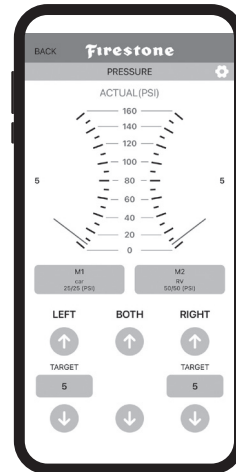

#### LEAK AT AIR TUBING AND AIR FITTING

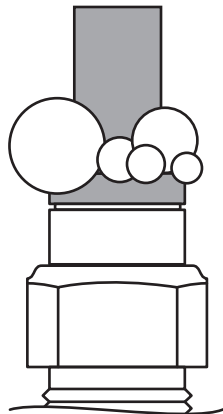

Release AirTubing (see page 4).  
Review proper cuts and procedures  
in Step 5. Repeat Step 5.

#### LEAK AT BASE OF AIR FITTING

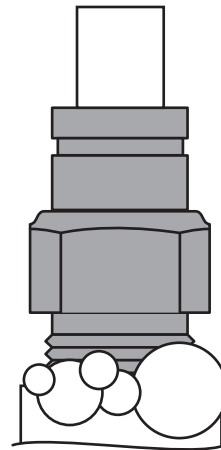

Tighten Air Fitting one turn  
or until leak stops.

## STILL HAVE A LEAK?

Refer to the Troubleshooting section of the Instruction Manual. If the leak persists, or if there is an issue with a leaking part, email us at [rtech@fsip.com](mailto:rtech@fsip.com). If emailing, please include photos to help us better diagnose and understand any problems you may be experiencing.



# AIRIDE

[firestoneairide.com](http://firestoneairide.com)

## BEFORE YOU DRIVE, CONFIRM THE FOLLOWING:

- Secure all AirTubing and wiring.
- The system passes the leak test and holds air.
- The Air Compressor ground ring terminal is contacting bare metal, and coated with silicone if possible.
- The Wire Harness is grounded to the negative (-) battery terminal. The ECU needs a good, clean, interference-free ground.
- There is a loop in the AirTubing as shown to prevent water or debris from getting into the Air Compressor head and damaging it.

Or, email us at [rrtech@fsip.com](mailto:rrtech@fsip.com). If emailing, please include photos to help us better diagnose and understand any problems you may be experiencing.

CONNECT WITH US



@firestoneairide



FirestoneAiride



Firestone Airide